



# UNIPOINT

VI SKABER TRYGHED

## SPECIAL ARMATUR



### TWT9141

TWT91 er et specialbygget panik armatur designet til forsænket montage i håndværn til trapper og rækværk. Armaturet har en robust konstruktion og er lavet af støbt aluminium. Reflektor er lavet af stødsikker og brandsikker polycarbonat. Man kan nedsætte omkostningerne ved at benytte master/slave systemet, hvor et adresserbar master-armatur styrer overvågningen af 2 slave-armaturer.

### Montage muligheder:

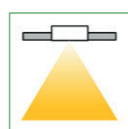

### Generelt

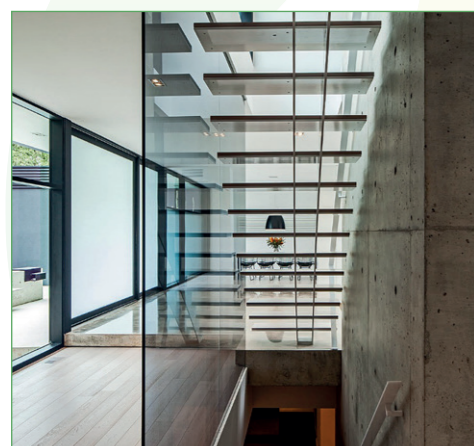
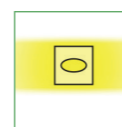
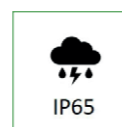
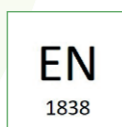
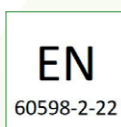

### Montageafstand med line-line.

|  |     |      |     |
|--|-----|------|-----|
|  | H m |      |     |
|  | 1,0 | 0,65 | 6,5 |

### Centralanlæg

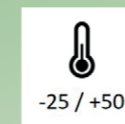
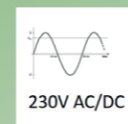

### GENERELT:

Montageform: Forsænket montage i et Ø 60,3 mm rør-håndværn.

### TILBEHØR MV.:

Ingen.

### OPTIONER:

Armaturet kan også leveres med adresse og kommunikationsmodul til forskellige centralanlægssystemer. Armaturet kan leveres i en master- eller slave-version.

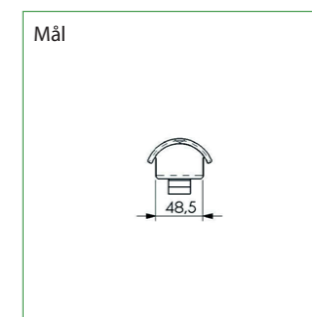
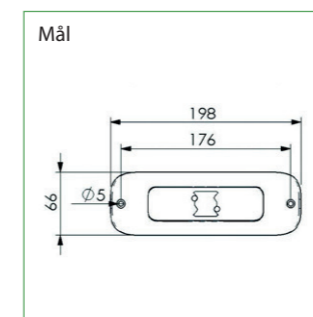
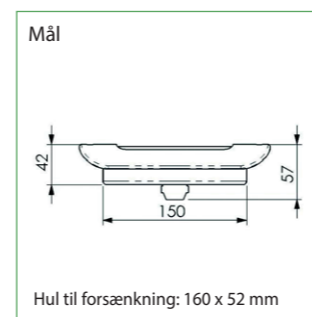

### Eksempel på installation i et håndværn i 26 graders vinkel.

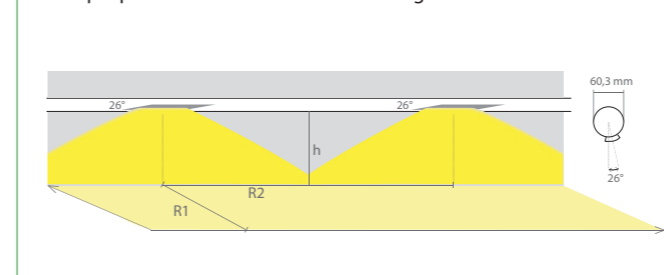

Vi tager forbehold for ændrede produkter og trykfejl.

### Eksempel på tilslutning af en adresserbar master og to slave-lys (alle lysene har den samme adresse). Master-lys kan også bruges alene.

